

**SAMSUNG**

**SAMSUNG Anycall**  
**SGH-X480**  
**SGH-X480C**  
**SGH-X488**

# ***SERVICE*** *Manual*

**SAMSUNG Anycall**



**CONTENTS**

1. Specification
2. Circuit Description
3. Exploded Views and Parts List
4. Electrical Parts List
5. Block Diagrams
6. PCB Diagrams
7. Flow Chart of Troubleshooting



This Service Manual is a property of Samsung Electronics Co.,Ltd.  
Any unauthorized use of Manual can be punished under applicable  
international and/or domestic law.

© Samsung Electronics Co.,Ltd. March. 2005  
Printed in Korea.

Code No.: GH68-06818A  
BASIC.

---

# 1. Specification

---

## 1. GSM General Specification

	EGSM 900 Phase 2	DCS 1800 Phase 1	PCS 1900 Phase 1
Freq. Band[MHz] Uplink/Downlink	880~915 925~960	1710~1785 1805~1880	1850~1910 1930~1960
ARFCN range	0~124 & 975~1023	512~885	512~810
Tx/Rx spacing	45MHz	95MHz	80MHz
Mod. Bit rate/ Bit Period	270.833kbps 3.692us	270.833kbps 3.692us	270.833kbps 3.692us
Time Slot Period/Frame Period	576.9us 4.615ms	576.9us 4.615ms	576.9us 4.615ms
Modulation	0.3GMSK	0.3GMSK	0.3GMSK
MS Power	33dBm~5dBm	30dBm~0dBm	30dBm~0dBm
Power Class	5pcl ~ 19pcl	0pcl ~ 15pcl	0pcl ~ 15pcl
Sensitivity	-102dBm	-100dBm	-100dBm
TDMA Mux	8	8	8
Cell Radius	35Km	2Km	2Km
Operating Temperature	-20 ℃ ~ +50 ℃		



---

## 2. Circuit Description

---

### 1. SGH-X480, SGH-X480C, SGH-X488 RF Circuit Description

#### 1) RX PART

1. ASM(F900) Switching Tx, Rx path for GSM900, DCS1800 and PCS1900 by logic controlling.

#### 2. ASM Control Logic Truth Table

	VC1	VC2	VC3
Tx (GSM900)	H	L	L
Tx (DCS1800/ PCS1900)	L	H	L
Rx (GSM900)	L	L	L
Rx (DCS1800)	L	L	L
Rx (PCS 1900)	L	L	H

#### 3. Saw FILTER

To convert Electromagnetic Field Wave to Acoustic Wave and then pass the specific frequency band.

- GSM FILTER (F800) For filtering the frequency band between 925 and 960 MHz.
- DCS FILTER (F800) For filtering the frequency band between 1805 and 1880 MHz
- PCS FILTER (F801) For filtering the frequency band between 1930 and 1990 MHz.

#### 4. Crystal (U802)

To generate the 26MHz reference clock to drive the logic and RF.

After additional process, the reference clock applies to the U801 Rx IQ demodulator and Tx IQ modulator.

The oscillator for RX IQ demodulator and Tx modulator are controlled by serial data to select channel and use fast lock mode for GPRS high class operation.

#### 5. Si4210 (U801)

The receive section integrates four differential-input low noise amplifiers LNAs supporting the GSM850, EGSM900, DCS1800 and PCS1900 bands. The LNA inputs are matched to the 150 ohm balanced-output SAW filters through external LC matching network.

A quadrature Image-reject mixer downconverts the RF signal to a 200 KHz intermediate frequency(IF). The mixer output is amplified with an analog programmable gain amplifier(PGA) that is controlled with the AGAIN. The quadrature IF is digitized with high resolution analog-to-digital converts (ADC).

The ADC output is downconverted to baseband with a digital quadrature LO signal. Digital decimation and FIR filters perform digital filtering and remove ADC quantization noise, blockers and reference interferers.

After filtering, the digital output is scaled with a digital PGA, which is controlled with the DGAIN. DACs drive a differential I and Q analog signal onto the BIP, BIN, BQP and BQN pins to interface to standard analog-input baseband ICs.

## 2) TX PART

Baseband IQ signal fed into offset PLL, this function is included inside of U801 chip. The transmit section of U801 consist of an I/Q baseband upconverter, an offset phase-locked loop (OPLL) and two 50 ohm output buffers that can drive an external Power Amplifier(PA). Si4210 chip generates modulator signal which power level is about 1.5dBm and fed into Power Amplifier(U900). The PA output power and power ramping are well controlled by Auto Power Control circuit. We use offset PLL below.

Modulation Spectrum	200kHz offset 30 kHz bandwidth	GSM	-35dBc
		DCS	-35dBc
		PCS	-35dBc
	400kHz offset 30 kHz bandwidth	GSM	-66dBc
		DCS	-65dBc
		PCS	-66dBc
	600kHz ~ 1.8MHz offset 30 kHz bandwidth	GSM	-75dBc
		DCS	-68dBc
		PCS	-75dBc

## 2. Baseband Circuit description of SGH-X480,SGH-X480C,SGH-X488

### 1) CSP2200B1

#### 1. Power Management

Seven low-dropout regulators designed specifically for GSM applications power the terminal and help ensure optimal system performance and long battery life. A programmable LDO provides support for 1.8V, 3.0V SIMs, while a self-resetting, electronically fused switch supplies power to external accessories. Ancillary support functions, such as two LED drivers and two call-alert drivers, aid in reducing both board area and system complexity. A four-wire serial interface unit(SIU) provides access to control and configuration registers. This interface gives a microprocessor full control of the CSP2200B1 and enables system designers to maximize both standby and talk times. Error reporting is provided via an interrupt signal and status register. Supervisory functions, including a reset generator, an input voltage monitor, and a thermal monitor, support reliable system design. These functions work together to ensure proper system behavior during start-up or in the event of a fault condition(low microprocessor voltage, insufficient battery energy, or excessive die temperature).

#### 2. Battery Charge Management

A battery charge management block, incorporating an internal PMOS switch, and an 8-bit ADC, provides fast, efficient charging of single-cell Li-Ion battery. Used in conjunction with a current-limited voltage source, this block safely conditions near-dead cells and provides the option of having fast-charge and top-off controlled internally or by the system's microprocessor.

### 3. Backlight LED Driver

The backlight LED driver is a low-side, programmable current source designed to control the brightness of the keyboard illumination. LED1\_DRV is controlled via LED1\_[0:2] and can be programmed to sink from 15mA to 60mA in 7.5mA steps. LED2\_DRV is controlled via LED2\_[0:2] and can be programmed to sink from 5mA to 40mA in 5mA steps. Both LED drivers are capable of sinking their maximum output current at a worst-case maximum output voltage of 0.6V. For efficient use, the LEDs is connected between the battery and the LED\_DRV output.

### 4. Vibrator Motor Driver

The vibrator motor driver is a independent voltage regulator to drive a small dc motor that silently alerts the user of an incoming call. The driver is a 3.3V constant source while sinking up to 140mA and controlled by enable signal of main chip. For efficient use and safety, the vibrator motor should be connected between the regulator output and the ground.

## 2) Connector

### 1. LCD Connector

LCD is consisted of main LCD(color 65K STN LCD). Chip select signals of EMI part in the trident, LCD\_CS, can enable main LCD. LED+ signal enables white LED of main LCD. In sleep mode, white LED are turned off.

These two signals are from IO part of the DSP in the trident. RST signal from CSP2200B1 initiates the initial process of the LCD.

8-bit data lines(D(0)~D(7)) transfers data and commands to LCD through emi\_filter. Data and commands use A(2) signal. If this signal is high, Inputs to LCD are commands. If it is low, Inputs to LCD are data.

The signals which inform the input or output state to LCD, are required. But this system is not necessary for read enable signal. CP\_WEN signal is only used to write data or commands to LCD.

Power signal for operating LCD driver is VCCD.

### 2. JTAG Connector

Trident has two JTAG ports which are for ARM core and DSP core(DSP16000). So this system has two port connector for these ports. Pins' initials for ARM core are 'CP\_' and pins' initials for DSP core are 'DSP\_'.

CP\_TDI and DSP\_TDI signal are used for input of data. CP\_TDO and DSP\_TDO signals are used for the output of the data. CP\_TCK and DSP\_TCK signals are used for clock because JTAG communication is a synchronous. CP\_TMS and DSP\_TMS signals are test mode signals. The difference between these is the RESET\_INT signal which is for ARM core RESET.

### 3. Keypad connector

This is consisted of key interface pins in the trident, KEY\_ROW[0~4] and KEY\_COL[0~4]. These signals compose the matrix. Result of matrix informs the key status to key interface in the trident. Some pins are connected to varistor for ESD protection. And power on/off key is separated from the matrix.

So power on/off signal is connected with CSP2200 to enable CSP2200.

Nine key LED use the +VBATT supply voltage. These are connected to BACKLIGHT signal in the CSP2200.

This signal enables LEDs with current control.

### 4. EMI Filtering

This system uses the EMI Filter to reduce noise from LCD part. Some control signals are connected to LCD without EMI filtering.

### 3) IF connector

It is 24-pin connector, and separated into two parts. One is a power supply part for main system. And the other is designed to use SDS, DEBUG, DLC-DETECT, JIG\_ON, VEXT, VTEST, VF, and GND. They connected to power supply IC, microprocessor and signal processor IC.

### 4) Audio

AOUTAP, AOUTAN from CSP2200 is connected to the speaker via analog switch. AOUTBP and AOUTBN are connected to the ear-mic speaker via ear-jack. MICIN and MICOUT are connected to the main MIC. And AUXIN and AUXOUT are connected to the Ear-mic.

YMU762MA3 is a LSI for portable telephone that is capable of playing high quality music by utilizing FM synthesizer and ADPCM decoder that are included in this device.

As a synthesis, YMU762MA3 is equipped 16 voices with different tones. Since the device is capable of simultaneously generating up to synchronous with the play of the FM synthesizer, various sampled voices can be used as sound effects. Since the play data of YMU762MA3 are interpreted at anytime through FIFO, the length of the data(playing period) is not limited, so the device can flexibly support application such as incoming call melody music distribution service. The hardware sequencer built in this device allows playing of the complex music without giving excessive load to the CPU of the portable telephones. Moreover, the registers of the FM synthesizer can be operated directly for real time sound generation, allowing, for example, utilization of various sound effects when using the game software installed in the portable telephone.

YMU762 includes a speaker amplifier with high ripple removal rate whose maximum output is 550mW (SPVDD=3.6V).

The device is also equipped with conventional function including a vibrator and a circuit for controlling LEDs synchronously with music.

For the headphone, it is provided with a stereophonic output terminal.

For the purpose of enabling YMU762MA3 to demonstrate its full capabilities, Yamaha purpose to use "SMAF:Synthetic music Mobile Application Format" as a data distribution format that is compatible with multimedia.



Since the SMAF takes a structure that sets importance on the synchronization between sound and images, various contents can be written into it including incoming call melody with words that can be used for training karaoke, and commercial channel that combines texts, images and sounds, and others. The hardware sequencer of YMU762MA3 directly interprets and plays blocks relevant to synthesis (playing music and reproducing ADPCM with FM synthesizer) that are included in data distributed in SMAF.

## 5) Memory

This system uses SHARP's memory, LRS18B0.

It is consisted of 256M bits flash memory and 64M bits SCRAM. It has 16 bit data line, D[0~15] which is connected to trident, LCD or CSP2200. It has 23 bit address lines, A[1~23]. They are also connected. CP\_CSROMEN signal, chip select signal in the trident, enable flash memories. They use supply voltages, VCCD and VCC\_1.8A.

During writing process, CP\_WEN is low and it enables writing process to flash memory and SCRAM. During reading process, CP\_OEN is low and it output information which is located at the address from the trident in the flash memory or SCRAM to data lines. Each chip select signals in the trident select flash memory or SCRAM. Reading or writing procedure is processed after CP\_WEN or CP\_OEN is enabled. Memories use FLASH\_RESET, which is buffered signal of RESET from CSP2200, for ESD protection. A[0] signal enables lower byte of SCRAM and UPPER\_BYTE signal enables higher byte of SCRAM.

## 6) Trident

Trident is consisted of ARM core and DSP core. It has 20K\*16bits RAM 144K\*16bits ROM in the DSP. It has 4K\*32bits ROM and 2K\*32bits RAM in the ARM core. DSP is consisted of timer, one bit input/output unit(BIO), JTAG, EMI and HDS(Hardware Development System). ARM core is consisted of EMI, PIC(Programmable Interrupt Controller), reset/power/clock unit, DMA controller, TIC(Test Interface Controller), peripheral bridge, PPI, SSI(Synchronous Serial Interface), ACCs(Asynchronous communications controllers), timer, ADC, RTC(Real-Time Clock) and keyboard interface. DSP\_AB[0~8], address lines of DSP core and DSP\_DB[0~15], data lines of DSP core are connected to CSP2200. A[0~20], address lines of ARM core and D[0~15], data lines of ARM core are connected to memory, LCD and YMU762. ICP(Interprocessor Communication Port) controls the communication between ARM core and DSP core.

CSROMEN, CSRAMEN and CS1N to CS4N in the ARM core are connected to each memory. WEN and OEN control the process of memory. External IRQ(Interrupt ReQuest) signals from each units, such as, YMU, Ear-jack, Ear-mic and CSP1093, need the compatible process.

Some PPI pins has many special functions. CP\_KB[0~9] receive the status from key FPCB and are used for the communications using data link cable(DEBUG\_DTR/RTS/TXD/RXD/CTS/DSR).

And UP\_CS/SCLK/SDI, control signals for CSP2200 are outputted through PPI pins. It has signal port for charging(CHG\_DET), SIM\_RESET and FLIP\_SNS with which we knows open.closed status of folder. It has JTAG control pins(TDI/TDO/TCK) for ARM core and DSP core. It receives 13MHz clock in CKI pin from external TCXO and receives 32.768KHz clock from X1RTC. ADC(Analog to Digital Convertor) part receives the status of temperature, battery type and battery voltage. And control signals(DSP\_INT, DSP\_IO and DSP\_RWN) for DSP core are used. It enables main LCD with DSP IP pins.

## 7) CSP2200

CSP2200 is integrated the timing and control functions for GSM 2+ mobile application with the ADC and DAC functions, and power management block. The CSP2200 interfaces to the trident, via a 16-bit parallel interface. It serves as the interface that connects a DSP to the RF circuitry in a GSM 2+ mobile telephone. DSP can load 148 bits of burst data into CSP2200's internal register, and program CSP2200's event timing and control register with the exact time to send the burst. When the timing portion of the event timing and control register matches the internal quarter-bit counter and internal frame counter, the 148 bits in the internal register are GMSK modulated according to GSM 2+ standards. The resulting phase information is translated into I and Q differential output voltages that can be connected directly to an RF modulator at the TXOP and TXON pins. The DSP is notified when the transmission is completed. For receiving baseband data, a DSP can program CSP2200's event timing and control register with the exact time to start receiving I and Q samples through TXIP and TXIN pins. When that time is reached, the control portion of the event timing and control register will start the baseband receive section converting I and Q sample pairs. The samples are stored in a double-buffered register until the register contains 32 sample pairs. CSP2200 then notifies the DSP which has sample time to read the information out before the next 32 sample pairs are stored. The voice band ADC converter issues an interrupt to the DSP whenever it finishes converting a 16-bit PCM word. The DSP then reads the new input sample and simultaneously loads the voice band output DAC converter with a new PCM output word. The voice band output can be connected directly to a speaker via AOUTAN and AOUTAP pins and be connected to a Ear-mic speaker via AOUTBN and AOUTBP pins.

There are 7 LDOs which are power sources of microprocessor, LCD, etc. These 7 LDOs output are programmable.

### 3. Exploded View and Parts list

#### 1. Cellular phone Exploded View-1

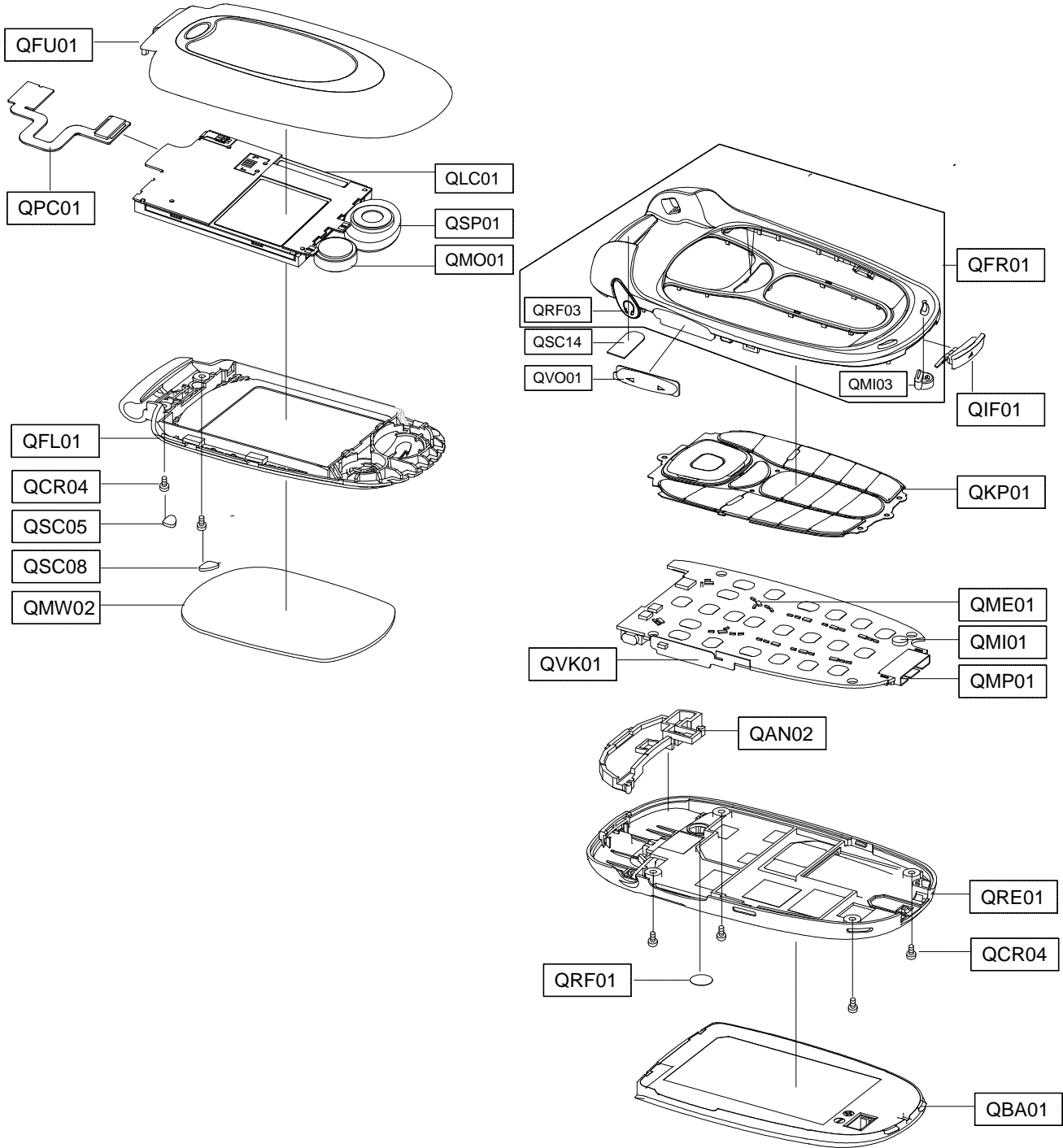

## 2. Cellular phone Parts list

Location NO.		Description	SEC CODE		
			SGH - X480	SGH - X480C	SGH - X488
QFR01		FRONT COVER	GH75 - 06162A	GH75 - 06162A	GH75 - 06162A
	QRF03	EAR COVER	GH72 - 19072A	GH72 - 19072A	GH72 - 19072A
	QMI03	MIC HOLDER	GH73 - 04031A	GH73 - 04031A	GH73 - 04031A
QSC14		FRONT SHEET	GH74 - 13673A	GH74 - 13673A	GH74 - 13673A
QVO01		SIDE KEY	GH72 - 19086A	GH72 - 19086A	GH72 - 19086A
QIF01		IF COVER	GH72 - 19085A	GH72 - 19085A	GH72 - 19085A
QKP01		KEYPAD	GH75 - 06188A	GH75 - 06663A	GH75 - 06663A
QME01		UNIT METAL DOME	GH59 - 01925A	GH59 - 01925A	GH59 - 01925A
QMI01		MICROPHONE ASSY	GH30 - 00119A	GH30 - 00119A	GH30 - 00119A
QMP01		MAIN PBA	GH92 - 02033A	GH92 - 02033A	GH92 - 02033A
QVK01		UNIT VOLUME KEY	GH59 - 01927A	GH59 - 01927A	GH59 - 01927A
QAN02		ANTENNA	GH42 - 00528A	GH42 - 00528A	GH42 - 00528A
QRE01		REAR COVER	GH75 - 06165A	GH75 - 06165A	GH75 - 06165A
QCR04		SCREW MACHINE	6001 - 001479	6001 - 001479	6001 - 001479
QRF01		TAPE RF SWITCH	GH74 - 12570A	GH74 - 12570A	GH74 - 12570A
QBA01		BATTERY	GH43 - 01661A	GH43 - 01729A	GH43 - 01729A
QFU01		FOLDER UPPER	GH75 - 06163A	GH75 - 06662A	GH75 - 06662A
QPC01		FPCB	GH41 - 00772A	GH41 - 00772A	GH41 - 00772A
QLC01		LCD	GH07 - 00655A	GH07 - 00655A	GH07 - 00655A
QSP01		SPEAKER	3001 - 001737	3001 - 001737	3001 - 001737
QMO01		MOTOR DC	GH31 - 00148A	GH31 - 00148A	GH31 - 00148A
QFL01		FOLDER LOWER	GH75 - 06164A	GH75 - 06164A	GH75 - 06164A
QCR04		SCREW MACHINE	6001 - 001479	6001 - 001479	6001 - 001479
QSC05		SCREW CAP R	GH74 - 12568A	GH74 - 12568A	GH74 - 12568A
QSC08		SCREW CAP L	GH74 - 12569A	GH74 - 12569A	GH74 - 12569A
QMW02		WINDOW MAIN	GH72 - 19120A	GH72 - 19120A	GH72 - 19120A

3. Test Jig (GH80-00865A)



3-1. RF Test Cable  
(GH39-00283A)



3-2. Test Cable  
(GH39-00127A)



3-3. Serial Cable



3-4. Power Supply Cable



3-5. DATA CABLE  
(GH39-00143B)



3-6. TA  
(GH44-00184A)





## 4. Electrical Parts List

SEC Code	Design LOC
0403-001387	ZD302
0403-001427	ZD303
0406-001190	U901
0406-001190	ZD304
0406-001190	ZD305
0406-001190	ZD306
0406-001201	V714
0406-001201	V715
0406-001201	V716
0501-000225	Q400
0504-000168	Q100
0505-001518	Q201
0801-000796	U102
1001-001294	U402
1009-001010	U702
1201-002174	U900
1203-003105	U206
1203-003105	U701
1203-003105	U703
1203-003304	U100
1204-002161	U401
1209-001219	U602
1405-001082	V203
1405-001082	V204
1405-001082	V205
1405-001082	V206
1405-001082	V405
1405-001082	V410
1405-001082	V411
1405-001082	V701
1405-001082	V702
1405-001082	V703
1405-001082	V704
1405-001082	V705
1405-001082	V706
1405-001082	V707
1405-001082	V708
1405-001082	V709
1405-001082	V710

SEC Code	Design LOC
1405-001082	V711
1405-001082	V713
1405-001093	V307
1405-001108	V401
1405-001108	V402
1405-001108	V403
1405-001108	V404
1405-001110	V207
2007-000138	R901
2007-000140	R115
2007-000140	R209
2007-000140	R305
2007-000140	R306
2007-000140	R307
2007-000140	R308
2007-000140	R309
2007-000140	R310
2007-000140	R311
2007-000140	R312
2007-000140	R313
2007-000140	R314
2007-000140	R316
2007-000140	R317
2007-000140	R427
2007-000140	R439
2007-000142	R414
2007-000145	R437
2007-000146	R406
2007-000148	R410
2007-000148	R618
2007-000148	R809
2007-000153	R113
2007-000155	R112
2007-000157	R405
2007-000157	R600
2007-000157	R608
2007-000162	R109
2007-000162	R114
2007-000162	R401

SEC Code	Design LOC
2007-000162	R607
2007-000162	R609
2007-000162	R617
2007-000162	R714
2007-000162	R715
2007-000167	R105
2007-000170	R601
2007-000171	R101
2007-000171	R104
2007-000171	R116
2007-000171	R315
2007-000171	R404
2007-000171	R416
2007-000171	R425
2007-000171	R502
2007-000171	R602
2007-000171	R616
2007-000171	R713
2007-000171	R800
2007-000171	R807
2007-000171	R808
2007-000172	R106
2007-000172	R108
2007-000172	R201
2007-000172	R501
2007-000173	R703
2007-000173	R705
2007-000173	R708
2007-000173	R902
2007-000174	R702
2007-000174	R704
2007-000174	R706
2007-000174	R707
2007-000174	R709
2007-000174	R710
2007-000174	R711
2007-000566	R300
2007-000566	R301
2007-000566	R302

SEC Code	Design LOC
2007-000566	R303
2007-000566	R304
2007-001217	R202
2007-001288	R210
2007-001291	R402
2007-001291	R403
2007-001291	R421
2007-001291	R423
2007-001308	R802
2007-001313	R903
2007-001317	R415
2007-001319	R103
2007-001320	R413
2007-001320	R418
2007-001325	R407
2007-001333	R435
2007-002797	R801
2007-007101	R417
2007-007101	R424
2007-007107	R408
2007-007107	R412
2007-007142	R111
2007-007142	R409
2007-007142	R411
2007-007142	R422
2007-007142	R603
2007-007308	R604
2007-007308	R605
2203-000233	C110
2203-000233	C211
2203-000233	C424
2203-000233	C501
2203-000233	C503
2203-000233	C801
2203-000254	C101
2203-000254	C118
2203-000254	C120
2203-000254	C205
2203-000254	C505



SEC Code	Design LOC
2203-000254	C601
2203-000254	C602
2203-000254	C603
2203-000254	C604
2203-000254	C608
2203-000254	C610
2203-000254	C611
2203-000254	C612
2203-000254	C613
2203-000254	C813
2203-000254	C914
2203-000278	C803
2203-000278	C808
2203-000278	C819
2203-000330	C619
2203-000330	C620
2203-000359	C401
2203-000386	C811
2203-000425	C415
2203-000438	C210
2203-000438	C418
2203-000438	C912
2203-000438	C915
2203-000438	C916
2203-000585	C408
2203-000628	C414
2203-000628	C431
2203-000679	C606
2203-000812	C105
2203-000812	C106
2203-000812	C107
2203-000812	C206
2203-000812	C207
2203-000812	C410
2203-000812	C411
2203-000812	C422
2203-000812	C432
2203-000812	C905
2203-000854	C302

SEC Code	Design LOC
2203-000854	C802
2203-000995	C413
2203-000995	C903
2203-000995	C913
2203-001017	C806
2203-001072	C102
2203-001072	C433
2203-001072	C434
2203-001072	C901
2203-001383	C908
2203-001385	C904
2203-001405	C607
2203-001412	C812
2203-001598	C109
2203-001598	C117
2203-002668	C906
2203-002677	C816
2203-002677	C817
2203-002687	C911
2203-005061	C108
2203-005061	C119
2203-005061	C124
2203-005061	C403
2203-005061	C404
2203-005061	C407
2203-005061	C419
2203-005061	C502
2203-005061	C504
2203-005061	C605
2203-005065	C121
2203-005234	C807
2203-005234	C809
2203-005288	C804
2203-005288	C805
2203-005288	C907
2203-005450	C818
2203-005482	C103
2203-005482	C201
2203-005482	C202

SEC Code	Design LOC
2203-005482	C204
2203-005482	C429
2203-005482	C703
2203-005482	C704
2203-005482	C810
2203-005482	C814
2203-005482	C815
2203-005496	C412
2203-005496	C420
2203-005496	C600
2203-005496	C618
2203-006090	C909
2203-006093	C112
2203-006093	C113
2203-006093	C114
2203-006093	C115
2203-006093	C116
2203-006093	C208
2203-006093	C701
2203-006093	C705
2203-006137	C405
2203-006190	C417
2203-006208	C416
2203-006324	C104
2203-006324	C209
2203-006324	C702
2203-006324	C706
2203-006438	C615
2404-001105	C425
2404-001105	C430
2404-001151	C423
2404-001239	C910
2404-001240	C111
2404-001268	C123
2404-001268	C125
2404-001268	C303
2404-001268	C402
2503-001041	C220
2503-001041	C221

SEC Code	Design LOC
2703-002170	L807
2703-002170	L901
2703-002199	L803
2703-002201	L903
2703-002201	L904
2703-002202	L401
2703-002202	L402
2703-002205	L805
2703-002339	L201
2703-002367	L902
2703-002558	L802
2703-002608	L806
2703-002815	L804
2801-003856	OSC600
2901-001286	U201
2901-001286	U202
2901-001286	U203
2904-001480	F801
2904-001523	F800
3301-001659	L301
3301-001729	L701
3705-001355	CON901
3709-001298	CN100
3710-001994	CN300
3711-005829	CN301
4302-001177	BAT100
GH09-00036A	U600
1108-000009	U500
1203-003663	U101
1203-003674	U200
2203-006562	C217
2203-006636	C216
2801-004426	U802
2911-000002	F900
3711-005885	CN200
3722-002067	CN401
0601-002020	D701
0601-002020	D702
0601-002020	D703

SEC Code	Design LOC
0601-002020	D704
0601-002020	D705
0601-002020	D706
0601-002020	D707
0601-002020	D708
0601-002020	D709
0601-002020	D711
1205-002683	U801



## 5. Block Diagrams

### 1. RF Solution Block Diagram

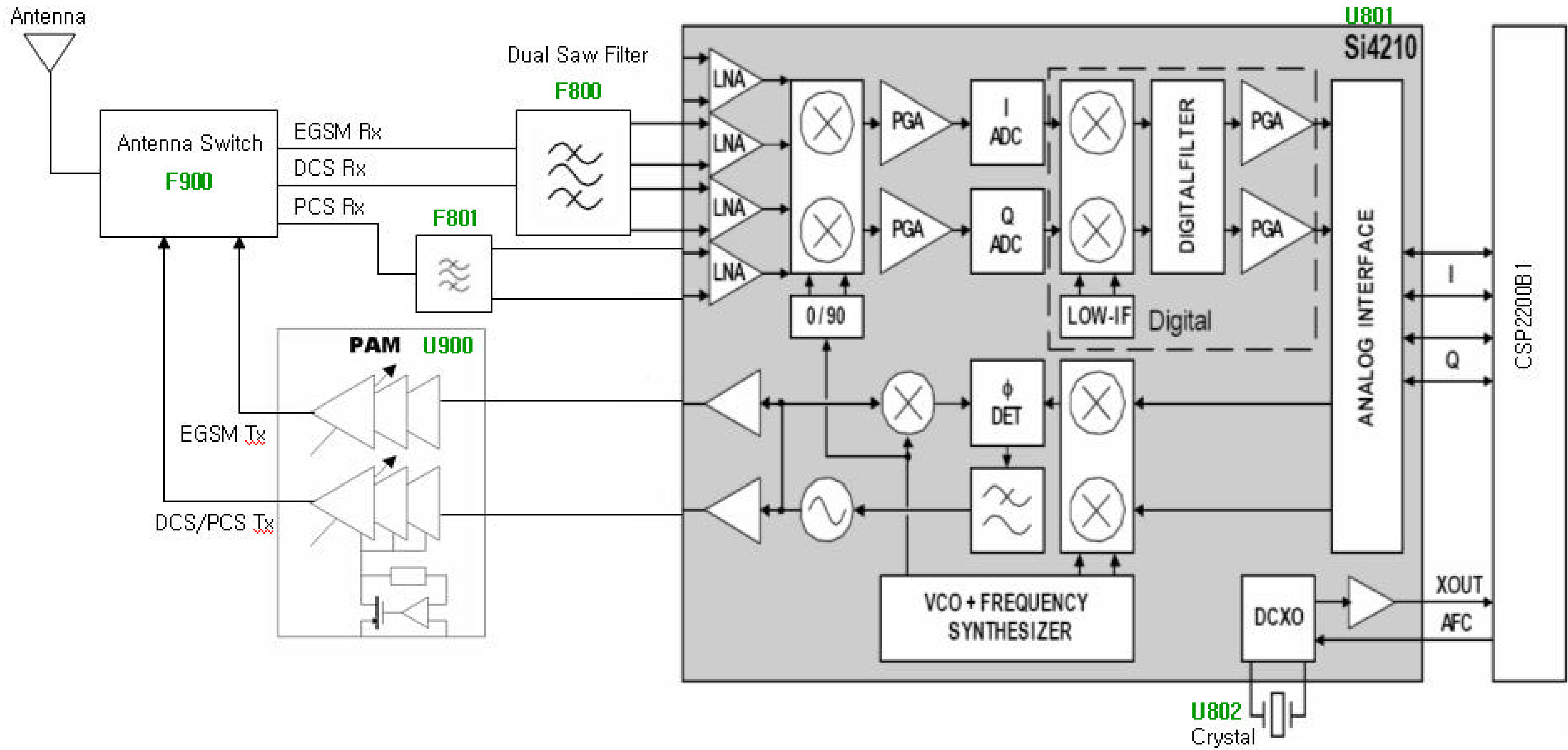

2. Base Band Solution Block Diagram

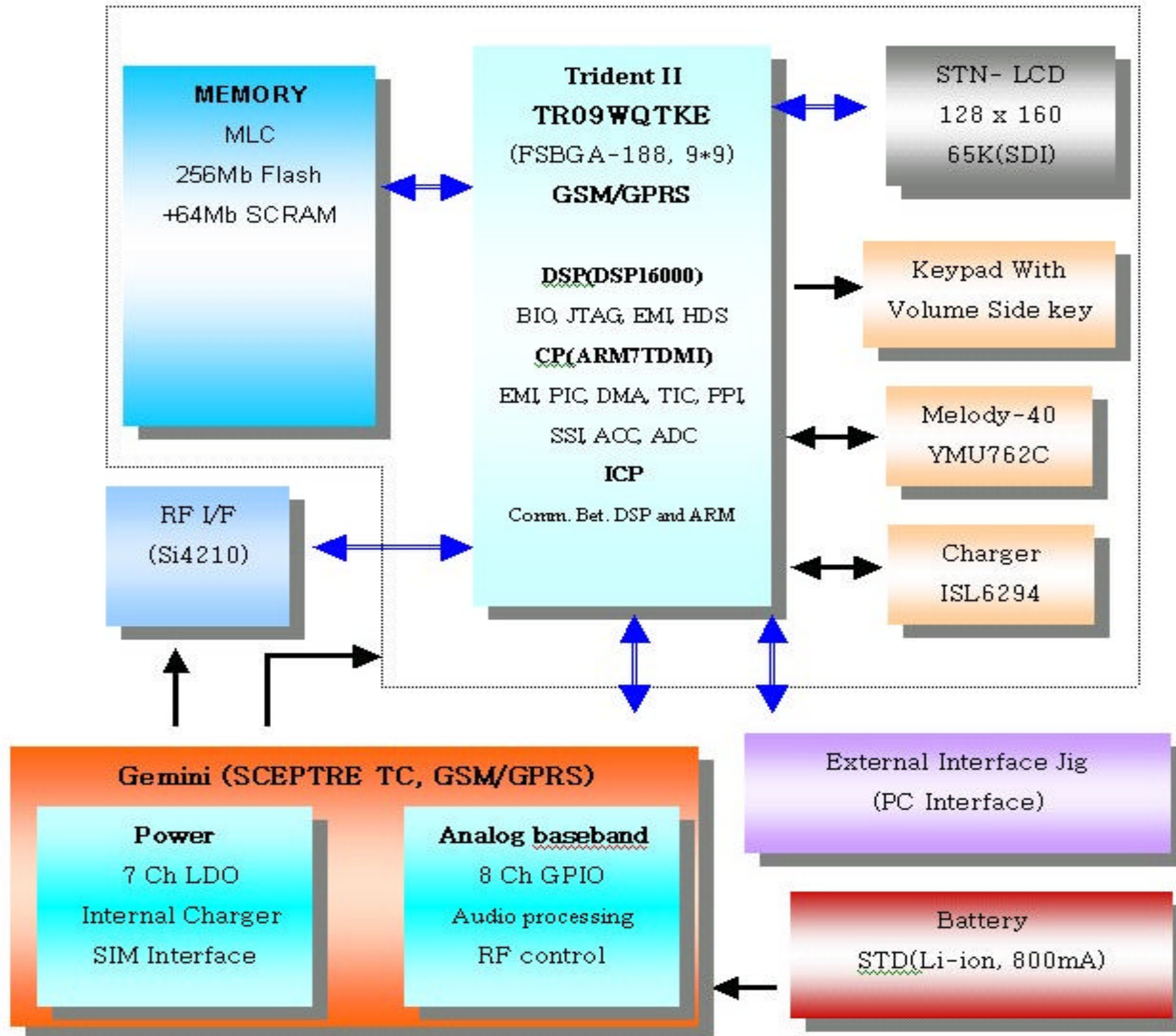

## 6. PCB Diagrams

### 1. Main PCB Top Diagram

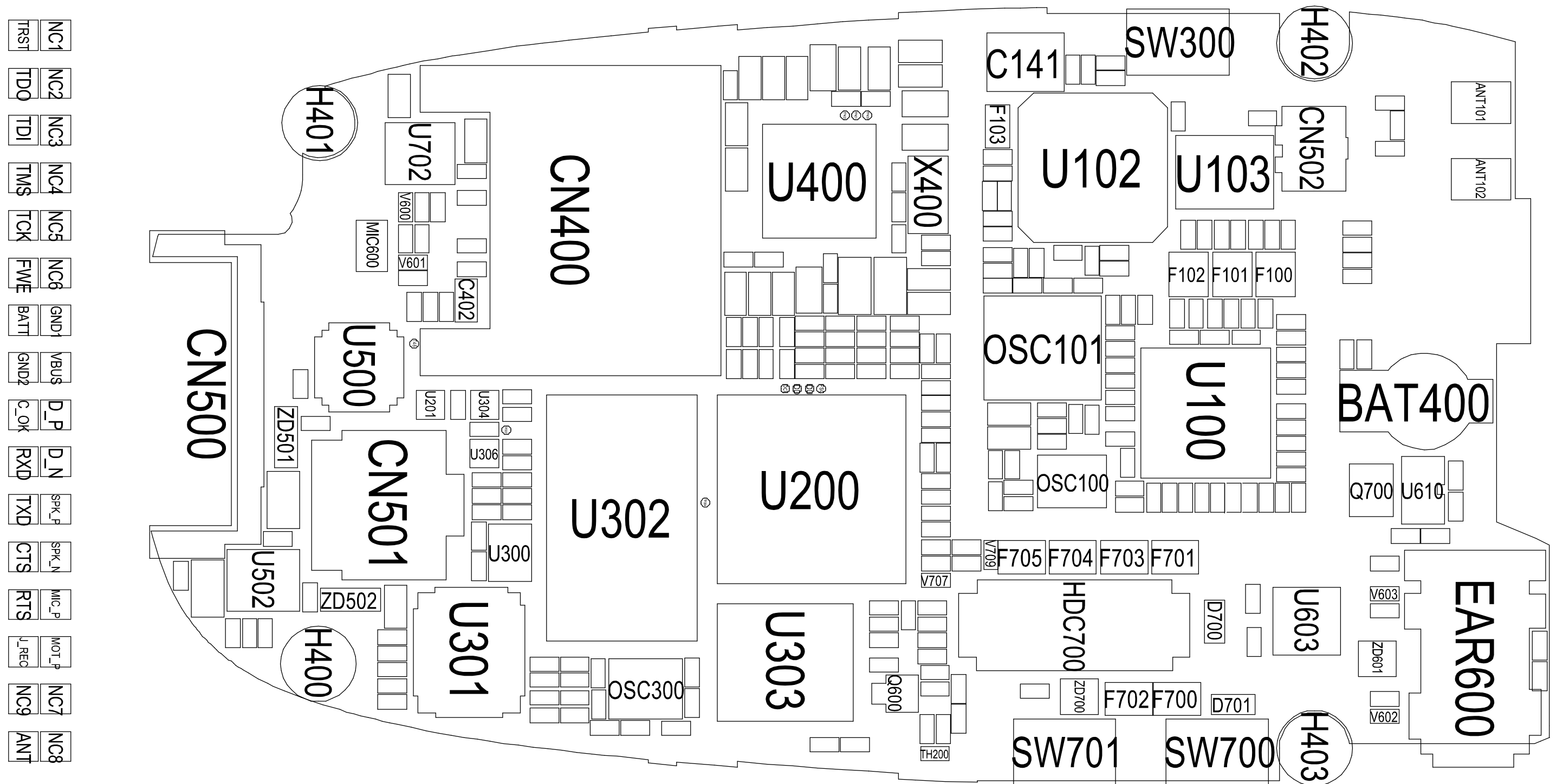

2. Main PCB Bottom Diagram

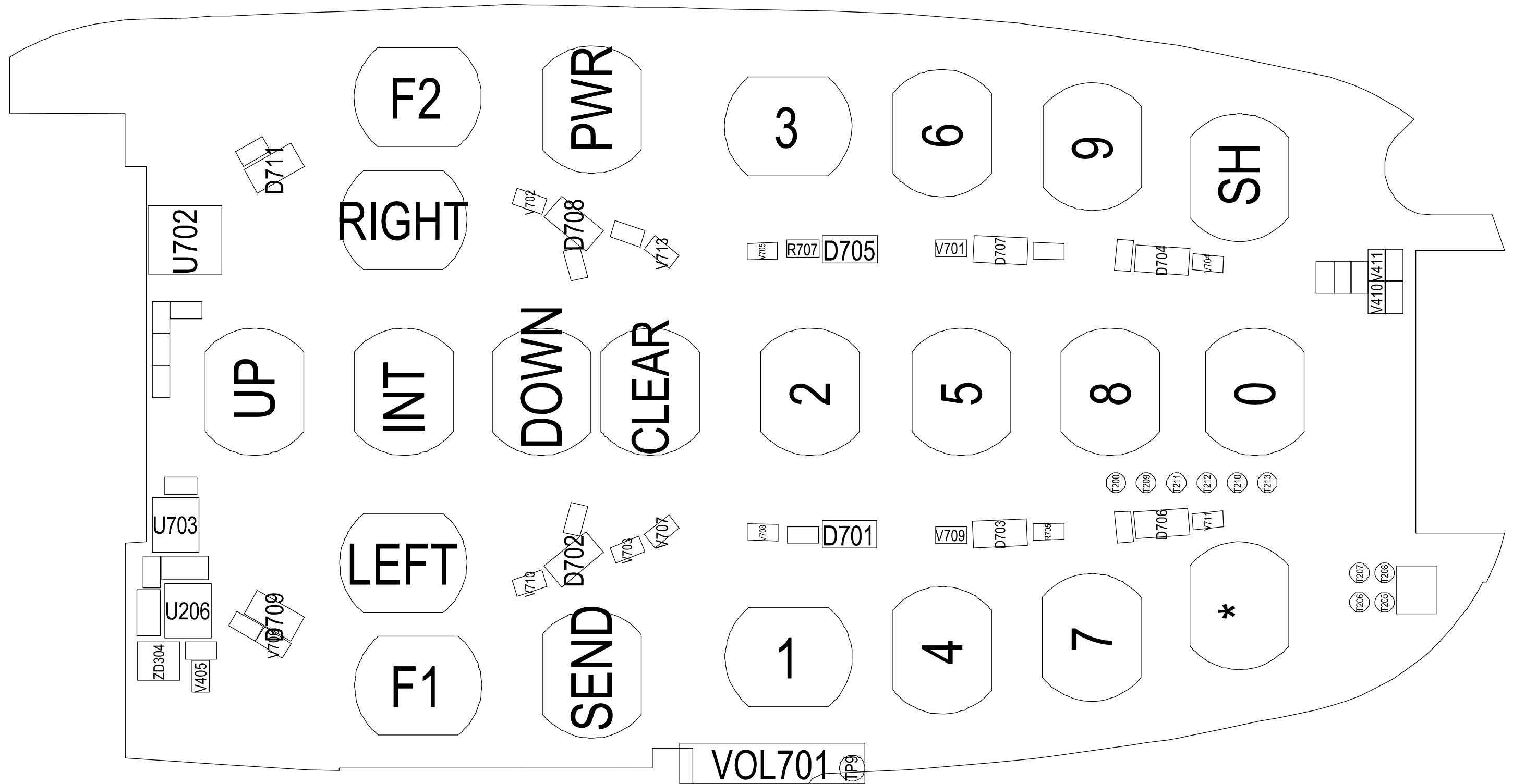



---

## 7. Flow Chart of Troubleshooting

---

### 1. Power On

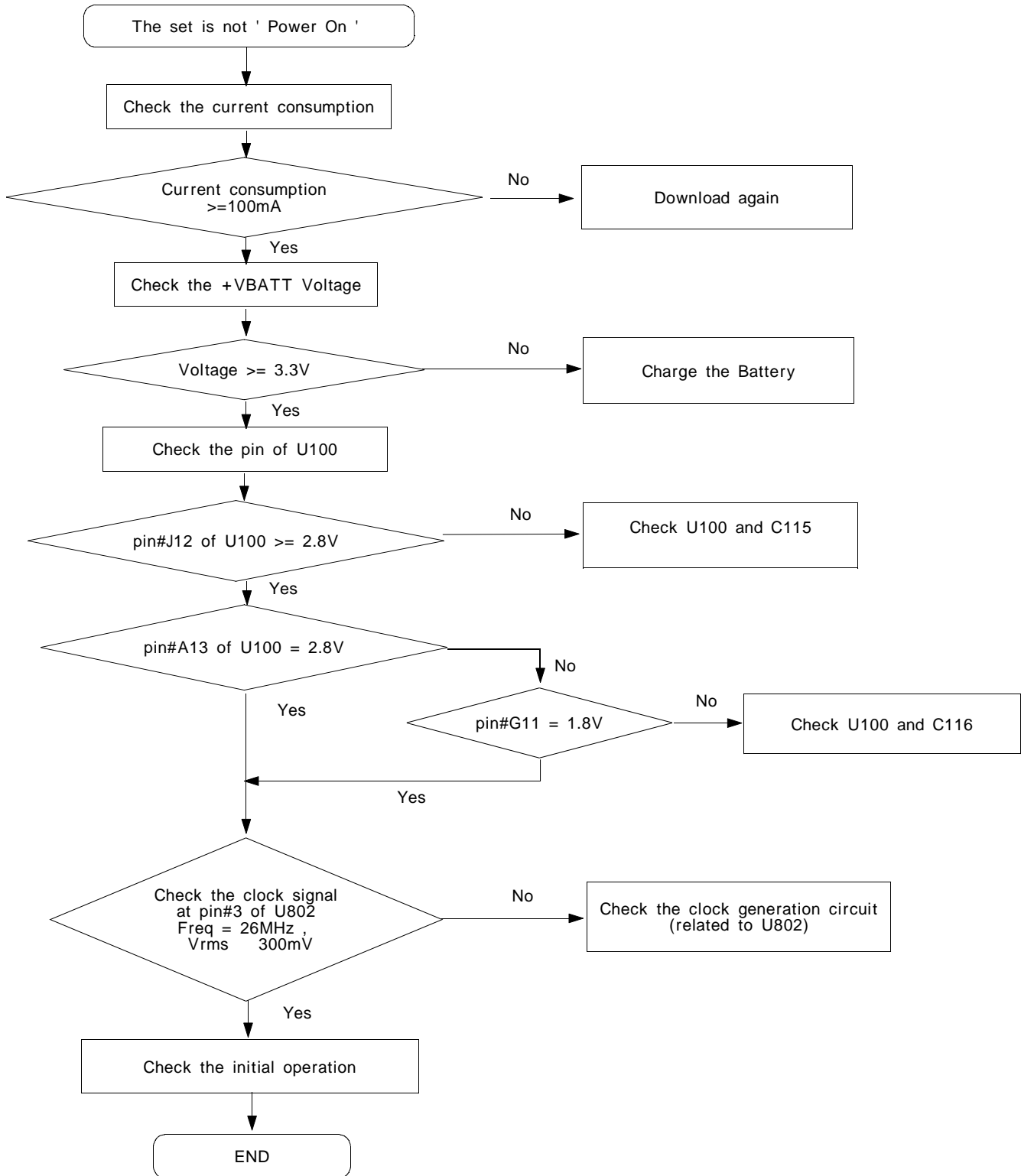

## 2. Initial

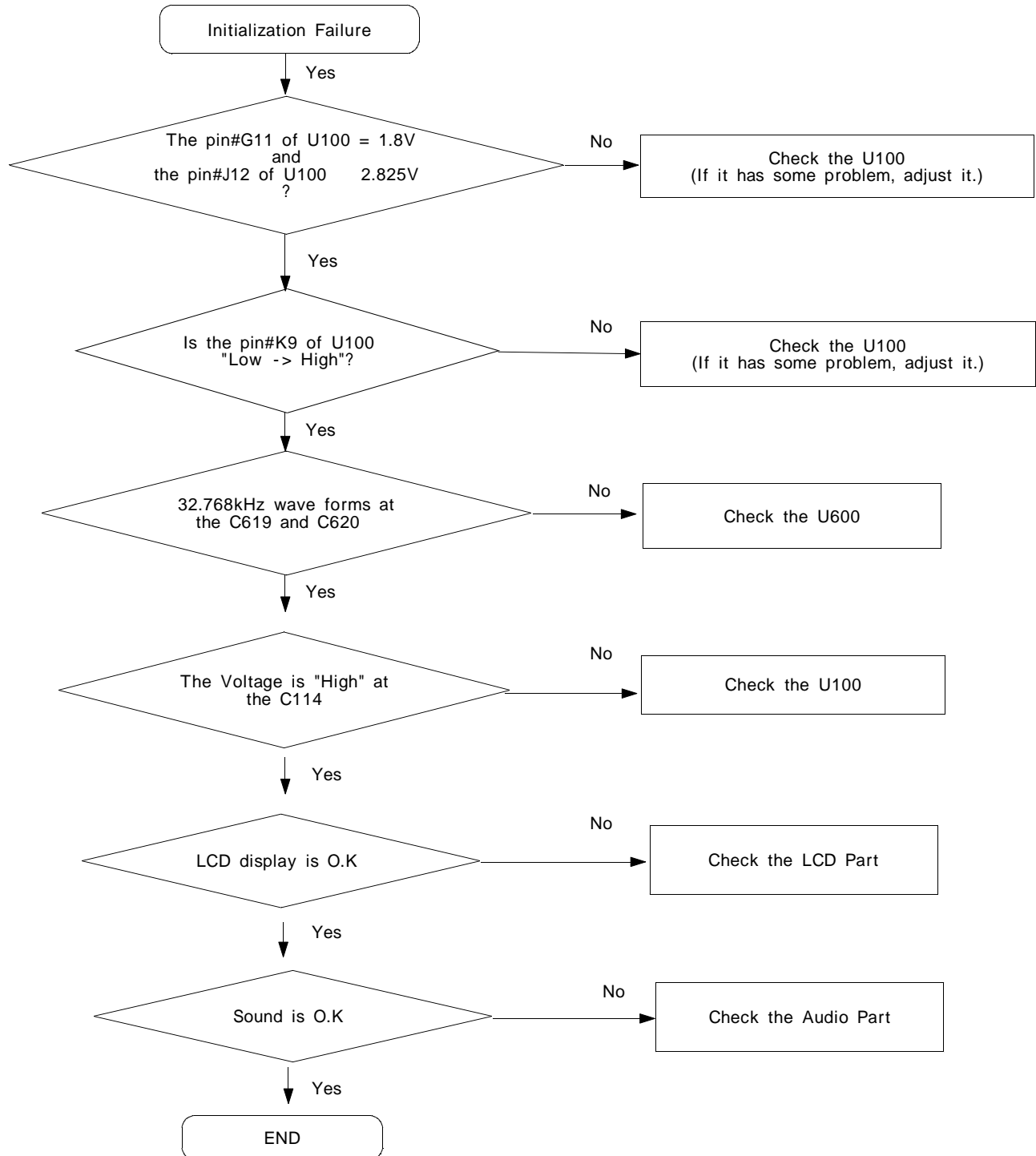

### 3. SIM Part

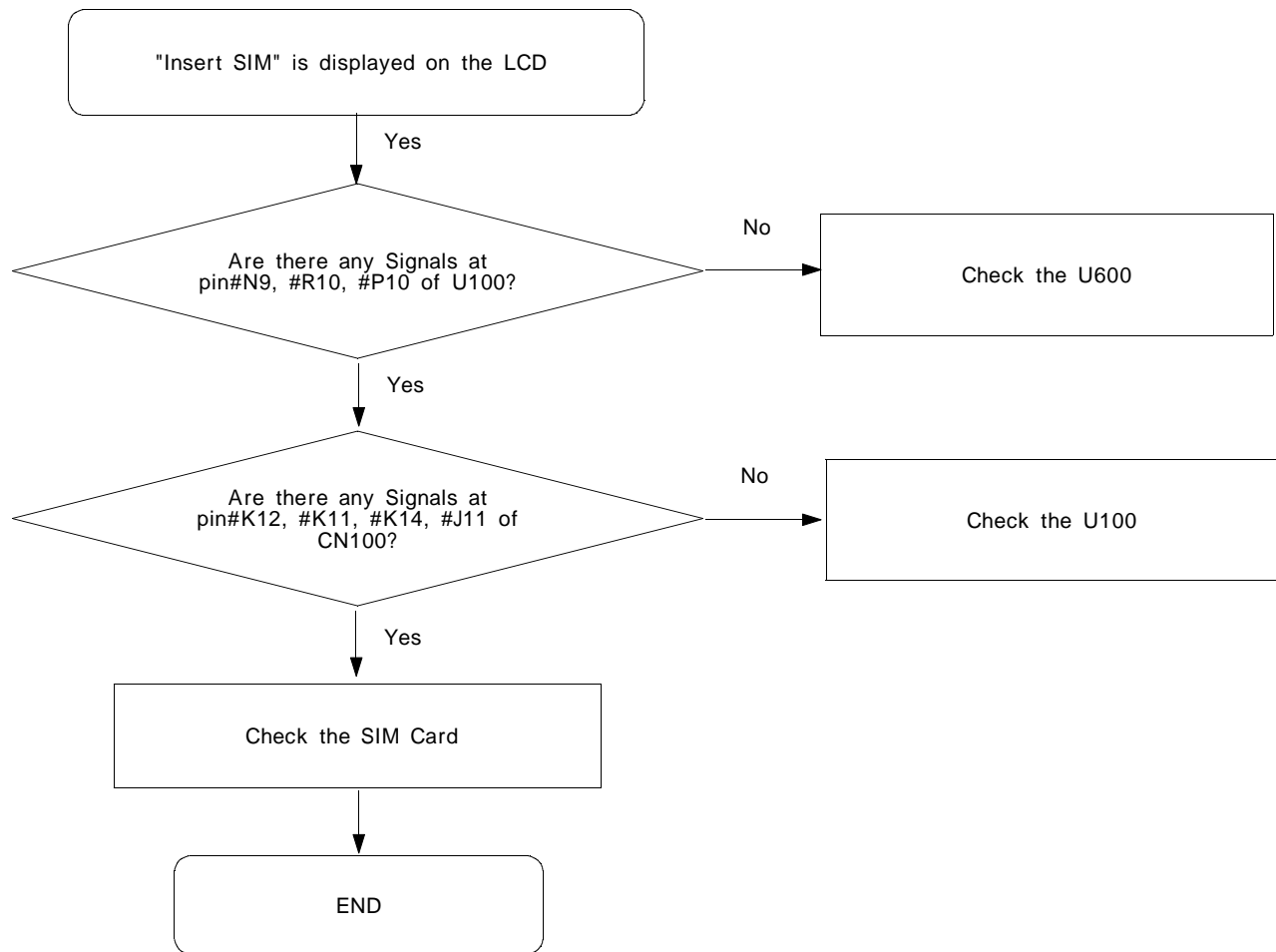

#### 4. Charging Part

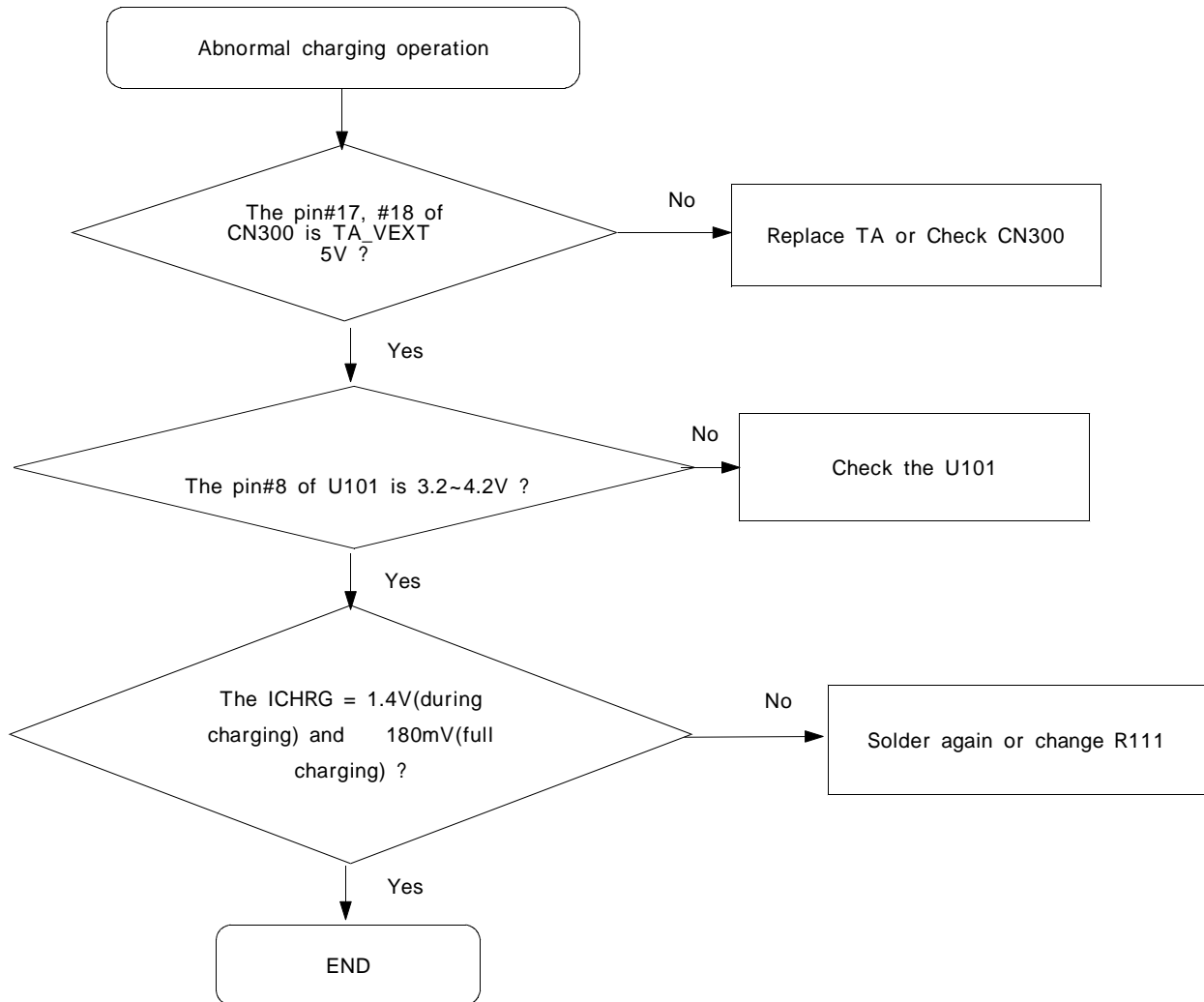

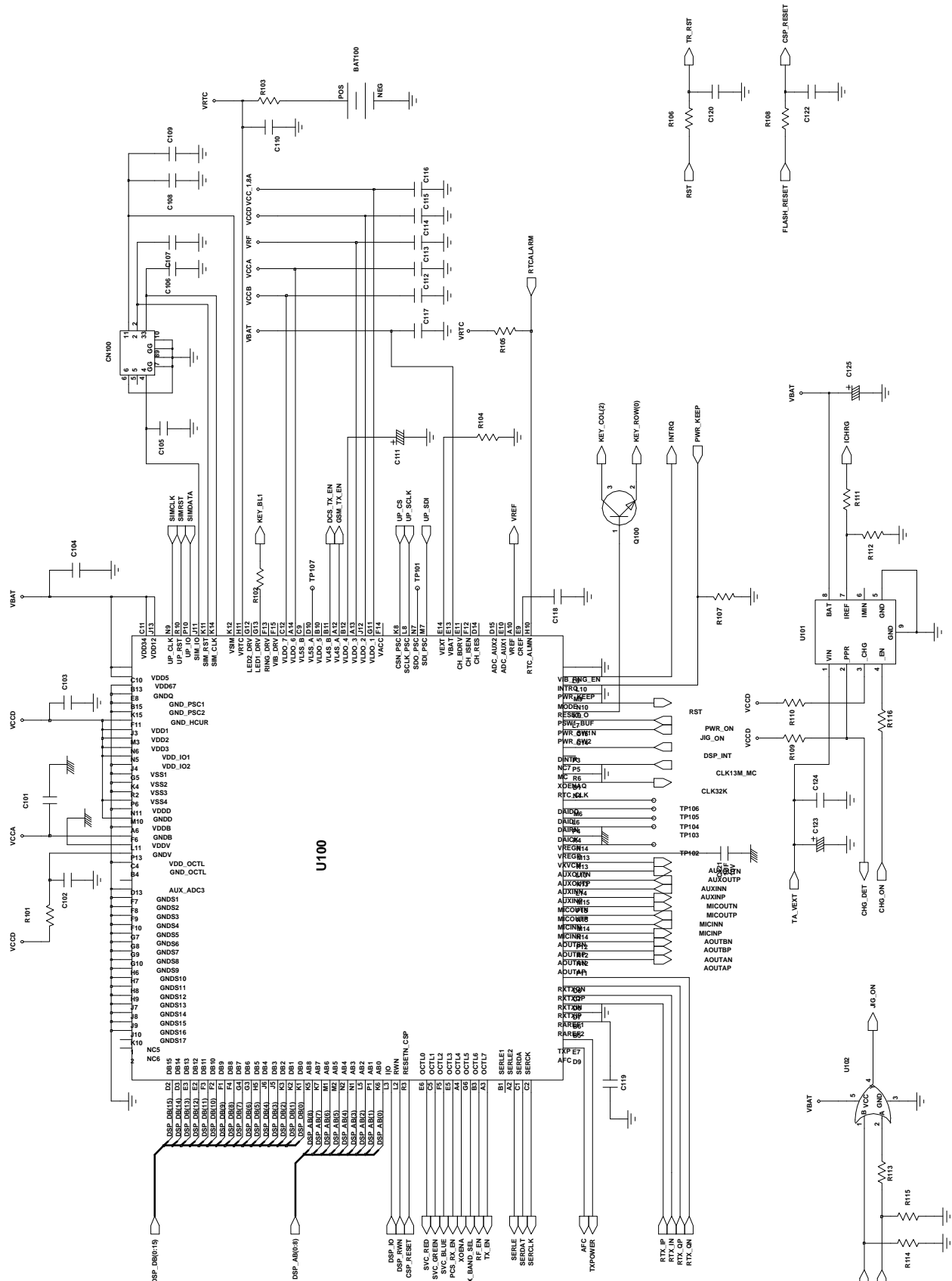

### 5. Microphone Part

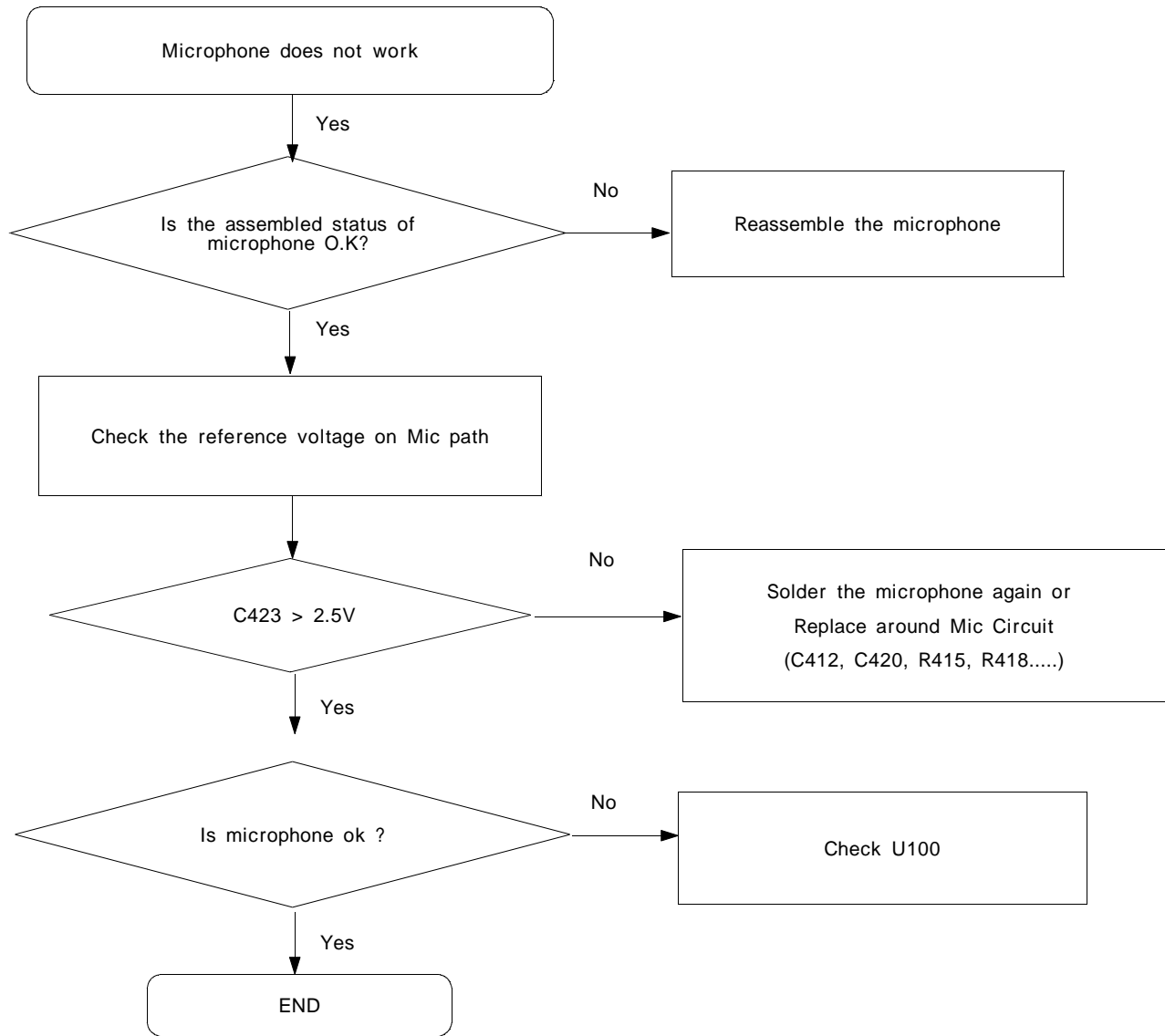

## 6. Speaker Part

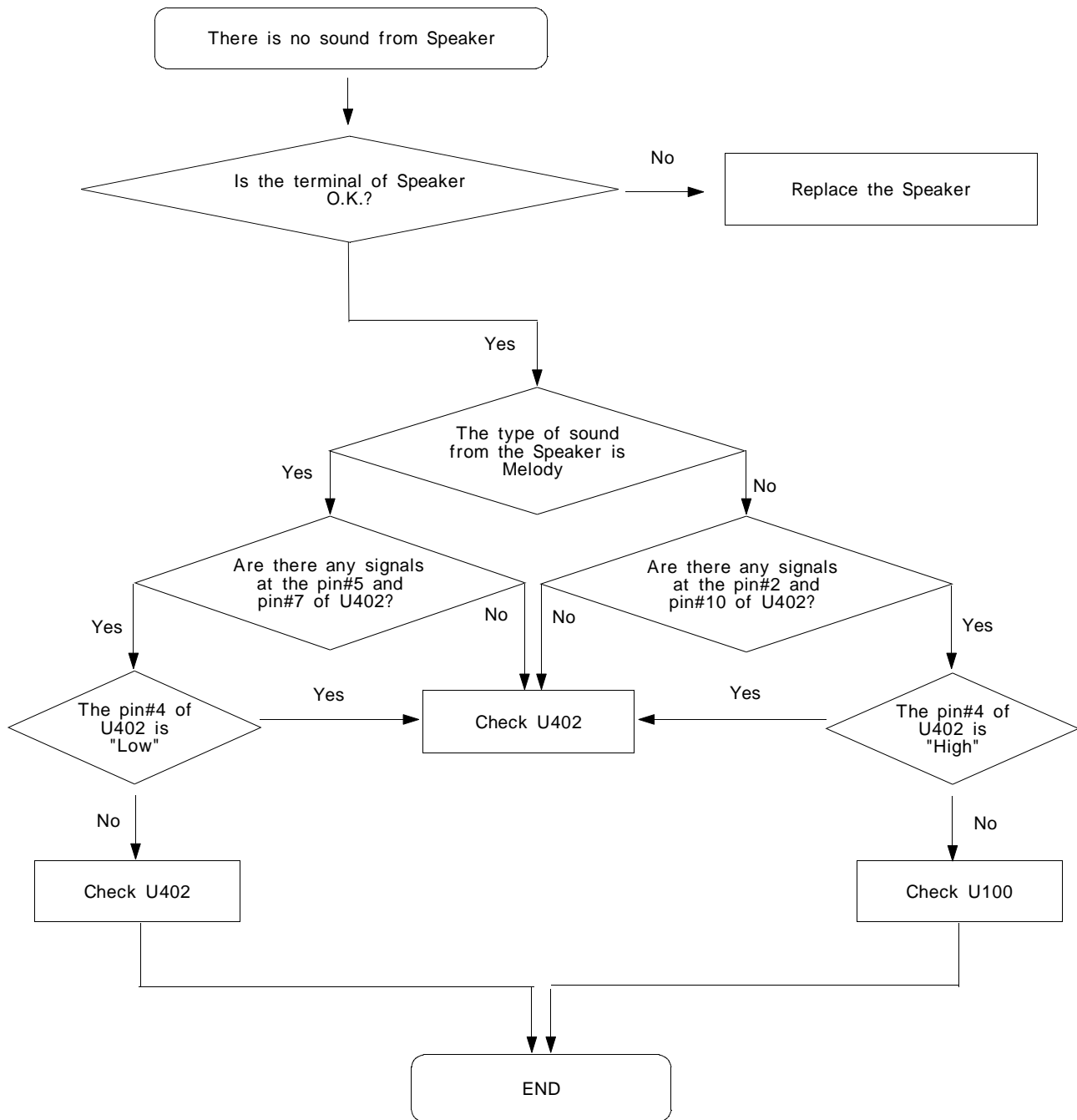

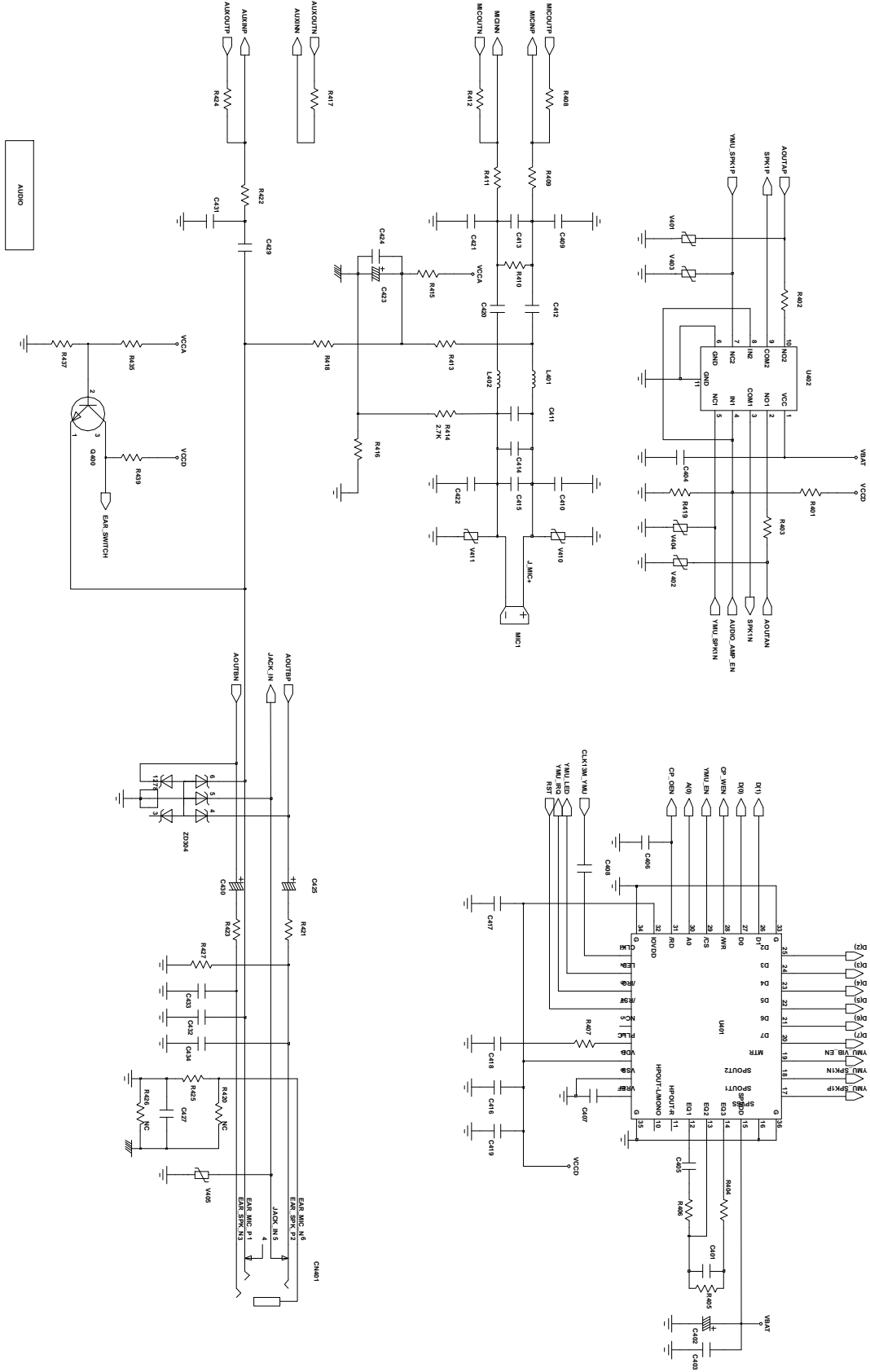



### 8. EGSM Reciever

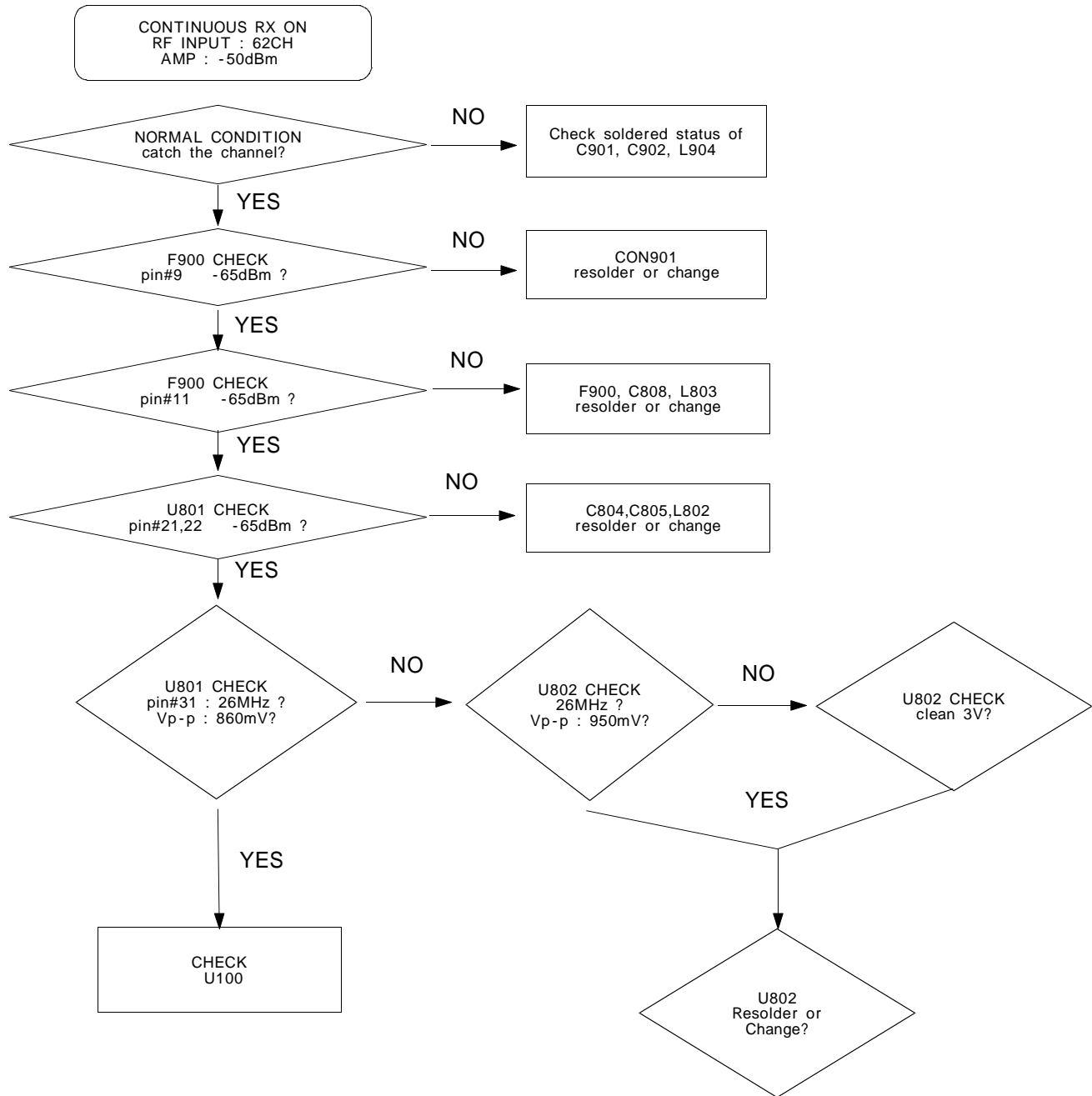

9. EGSM transmitter

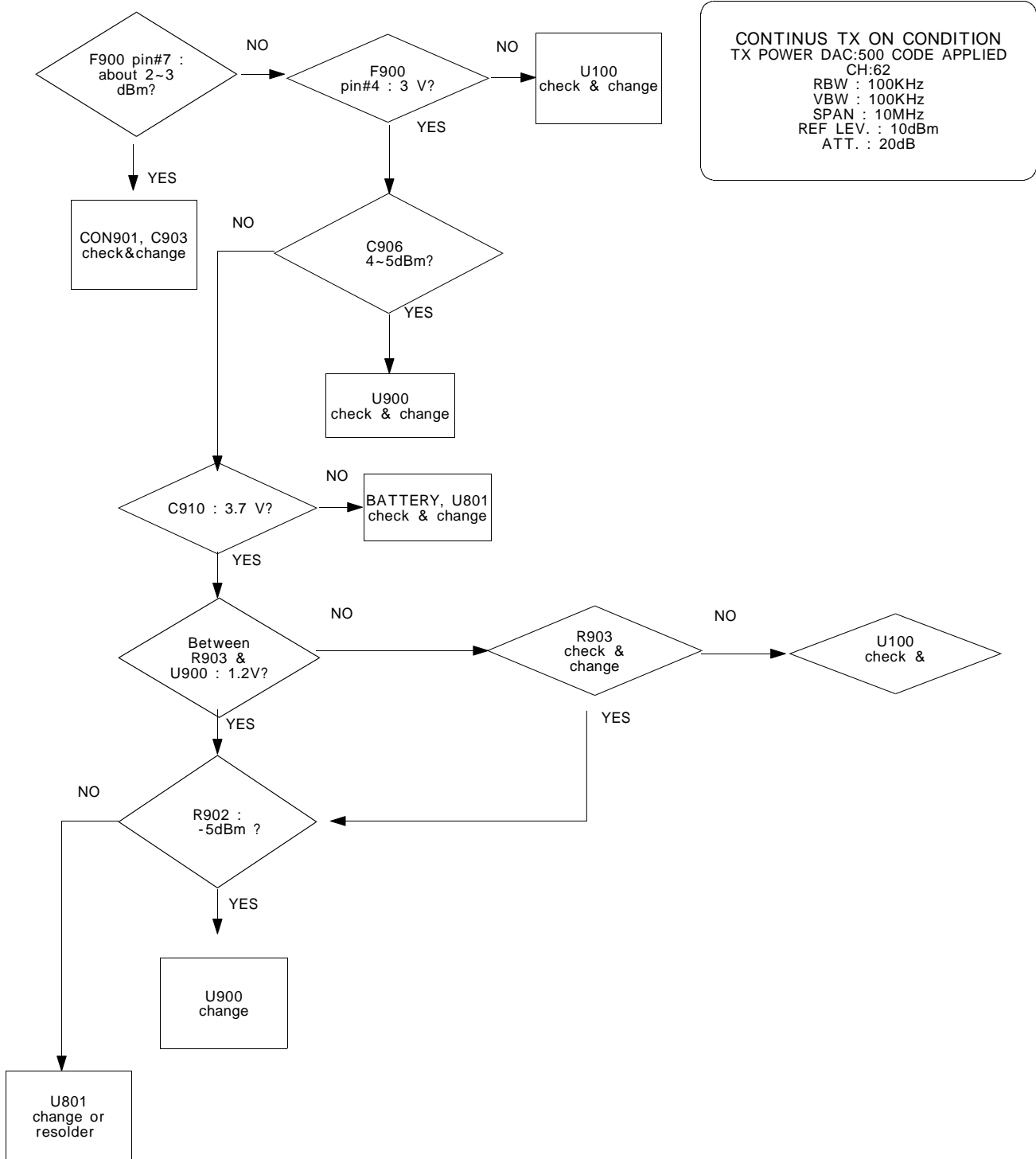

### 10. DCS Receiver

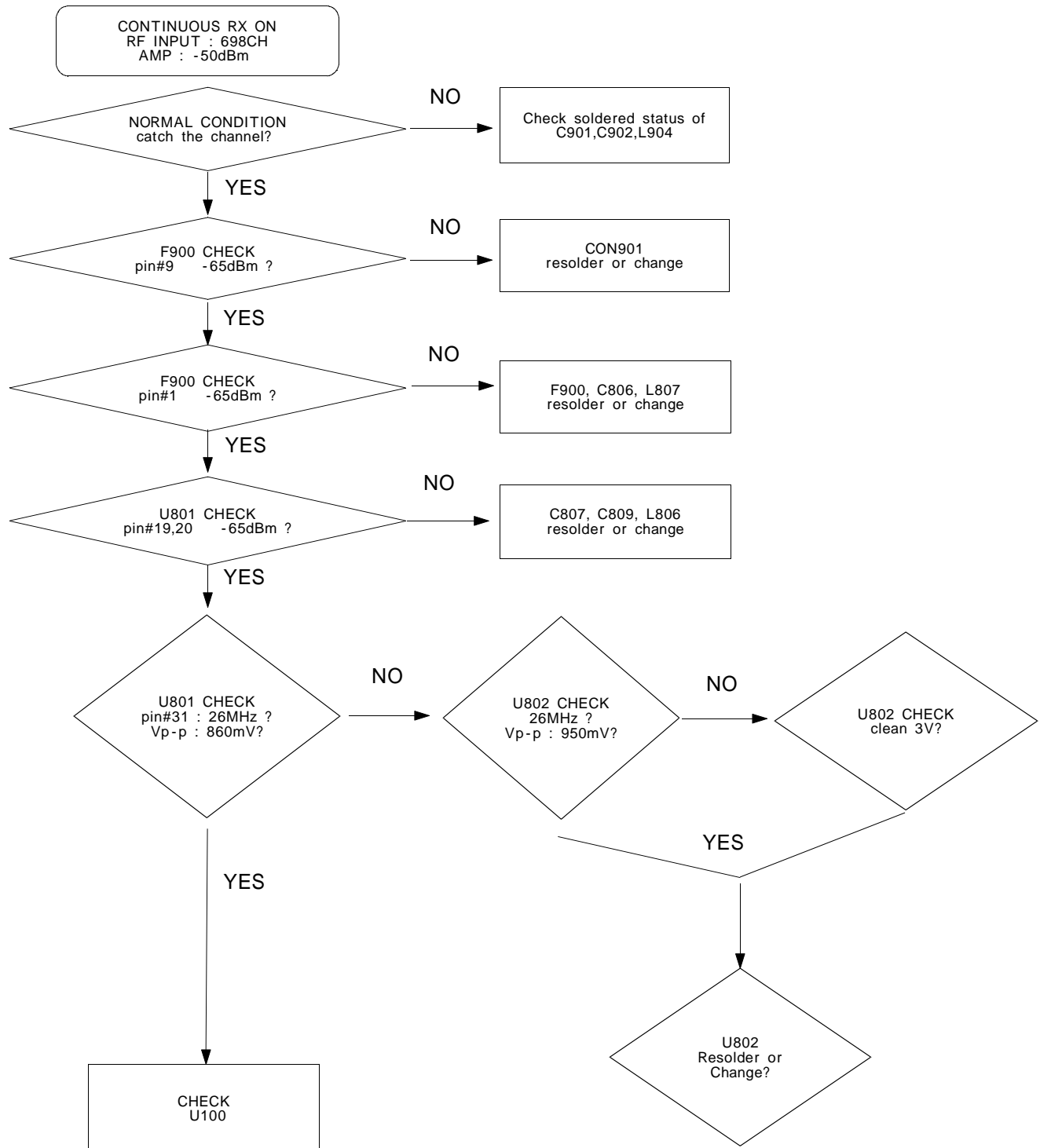

### 11. DCS transmitter

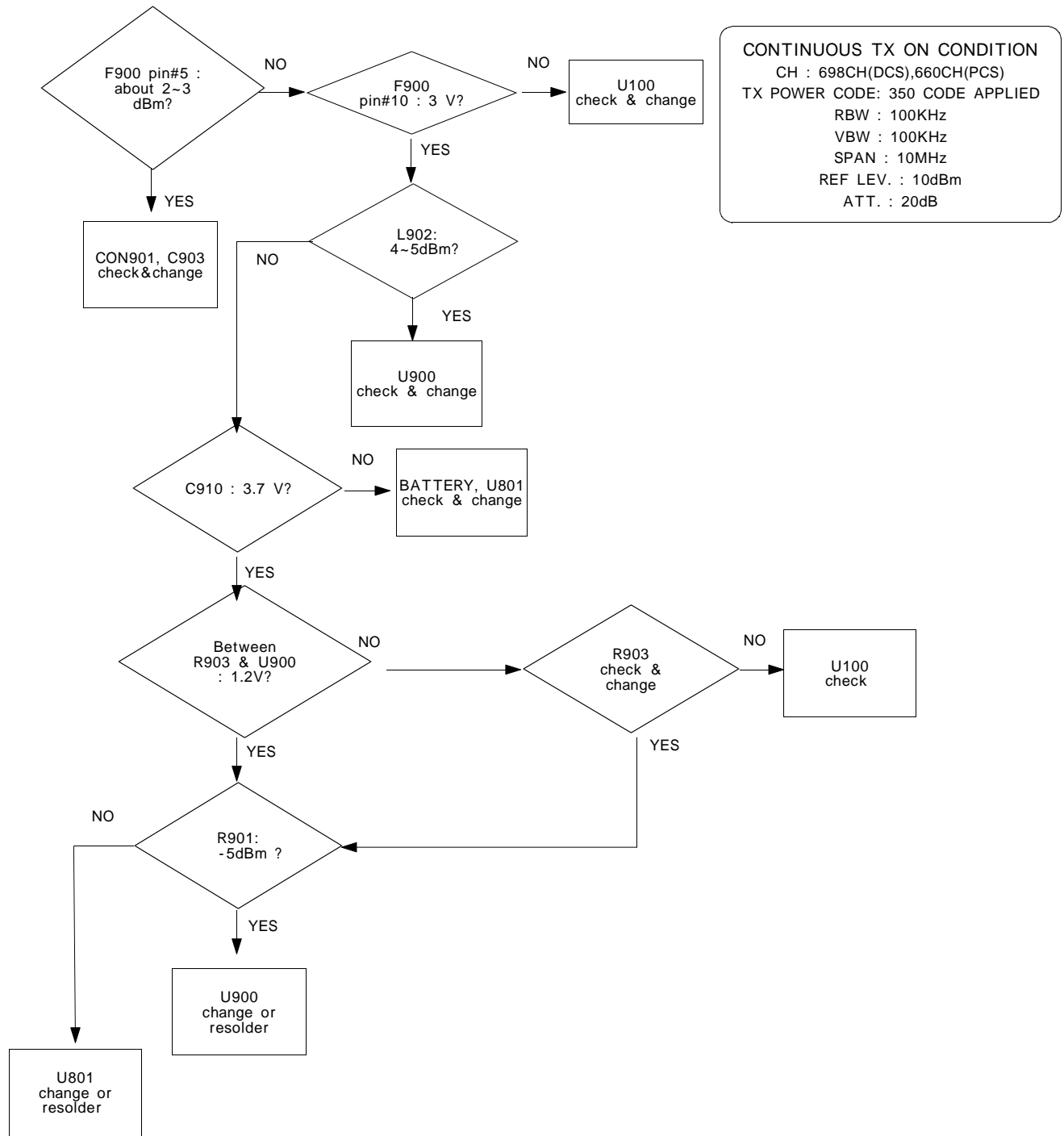

## 12. PCS Receiver

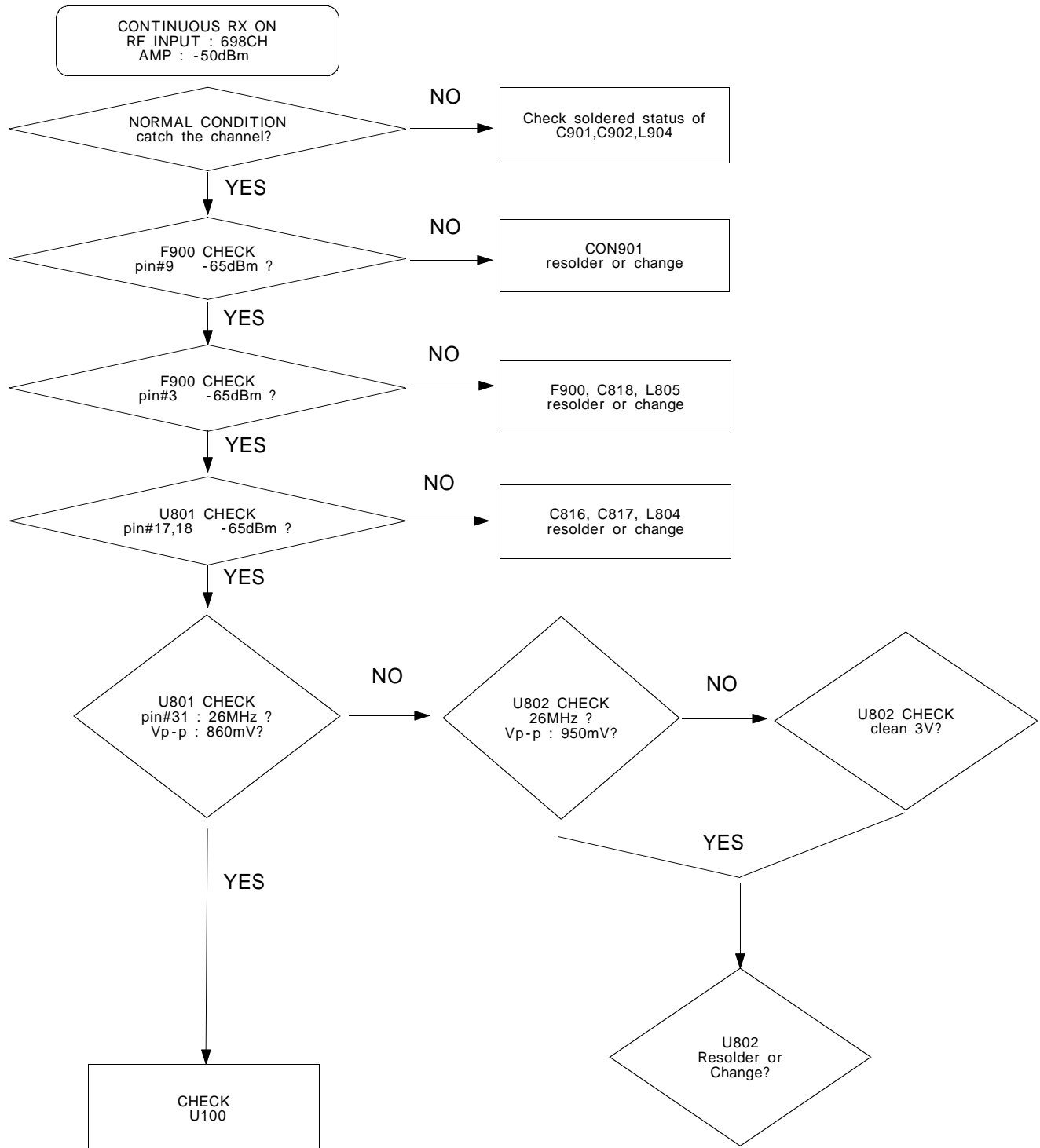

### 13. PCS transmitter

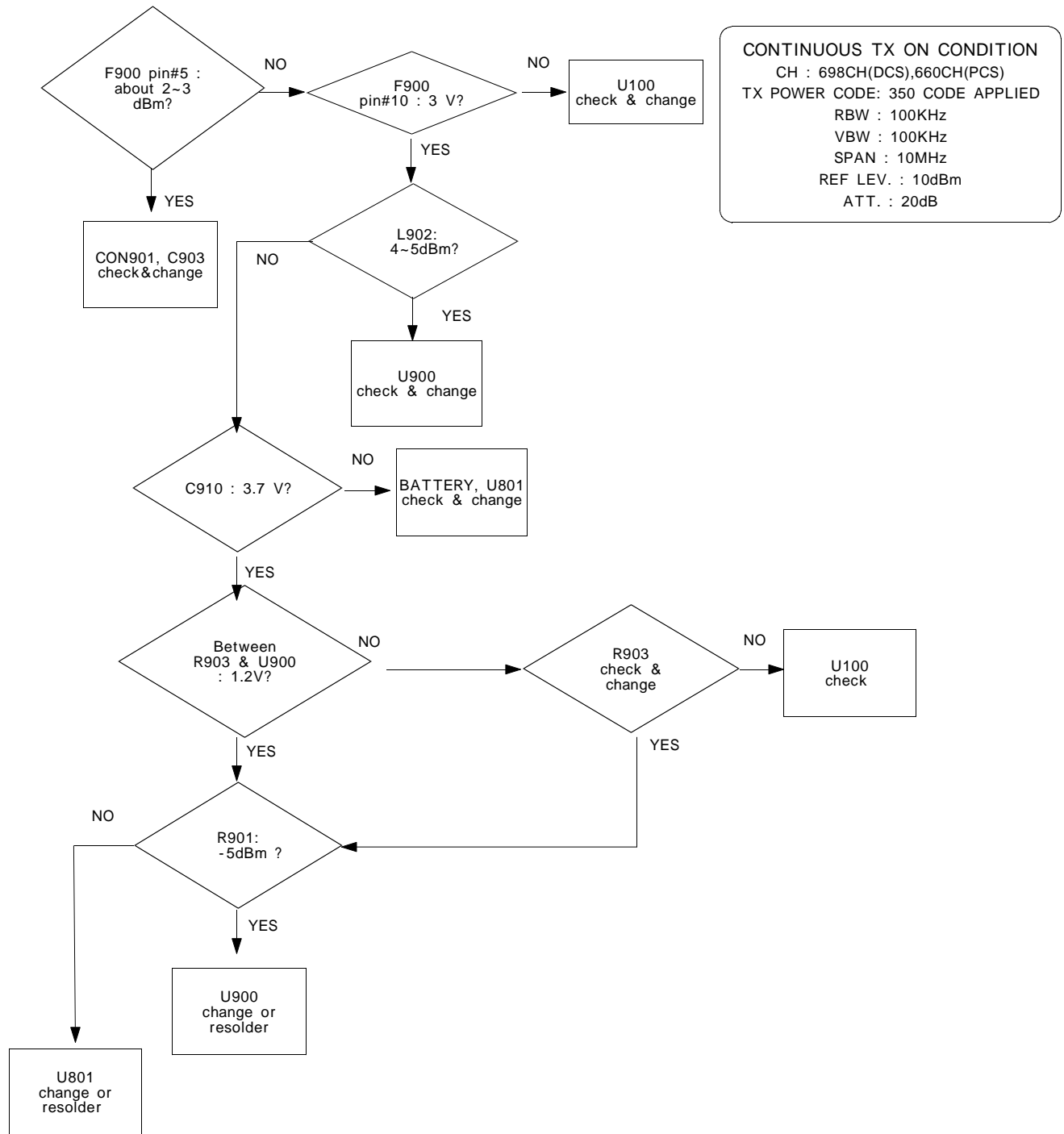

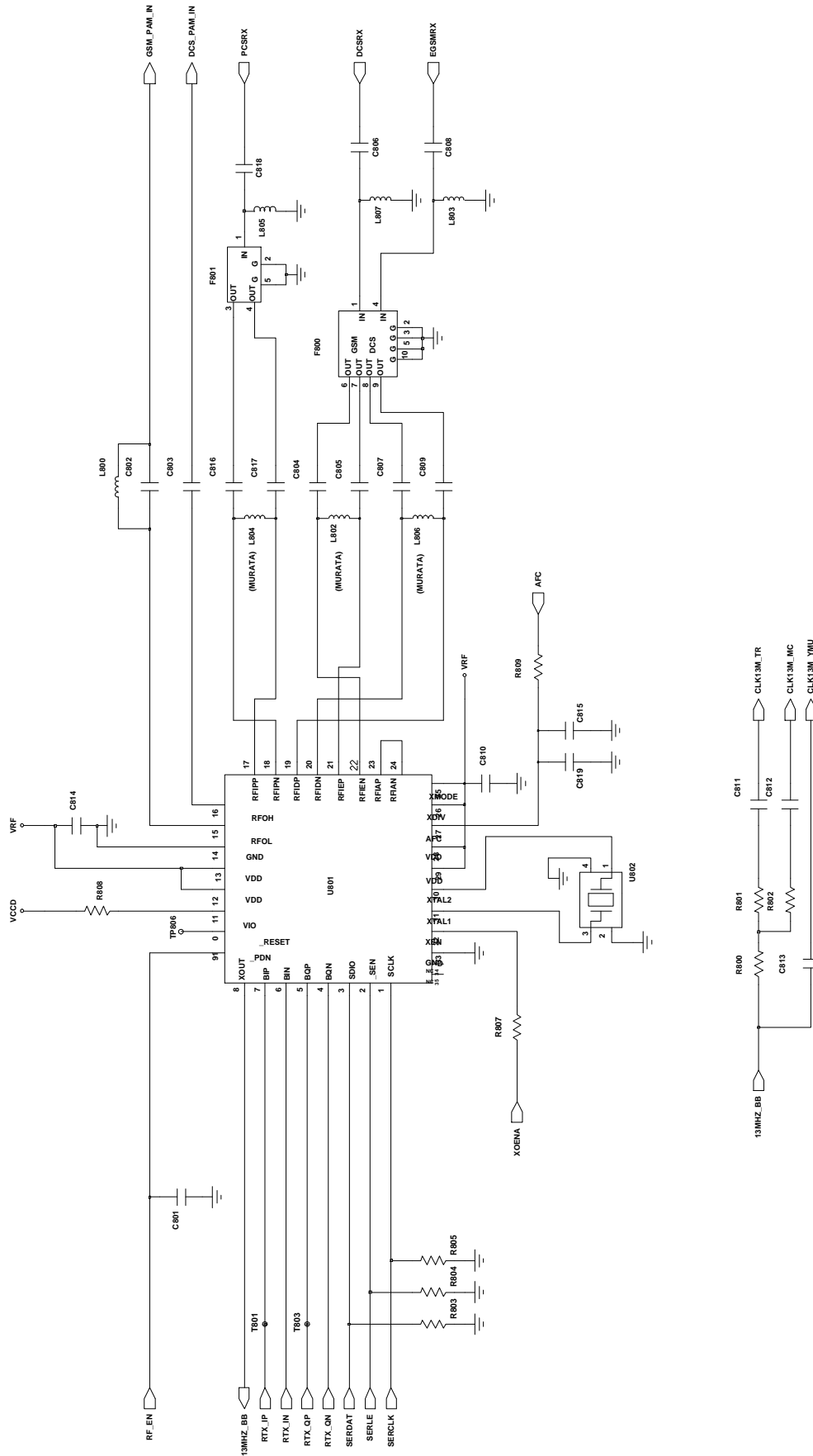

- 1) Toyocom & KSS to be reviewed
- 2) Toyocom samples to be reviewed starting 5/26/04 ; to coordinate with Toyocom on behalf of Mr.Park/Samsung

